



MVDS2



User Manual

System: MVDS2
Release: 1.1
Author: Simone Canepa

Summary.

SUMMARY	2
1 FIGURE INDEX	2
2 GENERAL DESCRIPTION	4
3 INSTALLATION	4
4 TECHNICAL SPECIFICATIONS	5
4.1 GENERAL SPECIFICATIONS.....	5
4.2 MECHANICAL SPECIFICATIONS.....	5
4.3 SYSTEM SPECIFICATIONS.....	5
4.3.1 <i>Transmitters</i>	5
4.3.1 <i>Receivers</i>	6
5 WEB INTERFACE	8
5.1 COMMON PARTS.....	9
5.1.1 <i>Status</i>	9
5.1.2 <i>Controller</i>	9
5.1.2.1 Controller Tab – Customer.....	9
5.1.2.2 Controller Tab – Network.....	10
5.1.2.3 Controller Tab – Traps Manager.....	11
5.1.2.4 Controller Tab – Tools.....	12
5.1.2.5 Controller Tab – Password management.....	12
5.1.3 <i>Upgrade</i>	13
5.1.4 <i>Log</i>	14
5.2 TRANSMITTERS.....	16
5.2.1 <i>Status</i>	16
5.2.2 <i>Config</i>	18
5.2.3 <i>Alarm</i>	20
6 RECEIVERS	21
6.1.1 <i>Status</i>	21
6.1.2 <i>Config</i>	22
6.1.3 <i>Alarm</i>	22
7 MECHANICS AND CONNECTORS	24
7.1 TRANSMITTERS.....	24
7.2 RECEIVERS.....	25

1 Figure Index.

FIGURE 1: WEB INTERFACE TX HOME PAGE.....	8
FIGURE 2: WEB STATUS FORM - COMMON PARAMETERS.....	9
FIGURE 3: WEB CONTROLLER TAB – CUSTOMER PARAMETERS.....	9
FIGURE 4: WEB CONTROLLER TAB – NETWORK PARAMETERS.....	10
FIGURE 5: WEB CONTROLLER TAB – TRAPS MANAGER.....	11
FIGURE 6: WEB CONTROLLER TAB – TRAPS MANAGER EMAIL.....	11
FIGURE 7: WEB CONTROLLER TAB – TOOLS.....	12
FIGURE 8: WEB CONTROLLER TAB –PASSWORD MANAGEMENT.....	12
FIGURE 9: WEB UPGRADE FORM.....	13
FIGURE 10: WEB LOG.....	14
FIGURE 11 : WEB LOG FORM – AVAILABLE LOG.....	15
FIGURE 12: WEB LOG FORM – AVAILABLE LOG EXPANDED.....	15
FIGURE 13: TX STATUS PAGE.....	16
FIGURE 14: SYSTEM INFO.....	16
FIGURE 15: L-BAND INPUT STATUS.....	17
FIGURE 16: KU CONVERTER STATUS.....	17

FIGURE 17: POWER AMPLIFIER STATUS	18
FIGURE 18: CONFIG BUTTON	18
FIGURE 19: WEB INTERFACE TX CONFIG PAGE - 1.	19
FIGURE 20: WEB INTERFACE TX CONFIG PAGE - 2.	19
FIGURE 21: ALARM BUTTON	20
FIGURE 22: WEB INTERFACE TX ALARM PAGE.....	20
FIGURE 23: RX STATUS PAGE.....	21
FIGURE 24: SYSTEM INFO.....	21
FIGURE 25: RECEIVER STATUS.....	21
FIGURE 26: CONFIG BUTTON	22
FIGURE 27: WEB INTERFACE RX CONFIG PAGE.....	22
FIGURE 28: ALARM BUTTON	22
FIGURE 29: WEB INTERFACE RX ALARM PAGE.	23
FIGURE 30: CONNECTORS TX MVDS2	24
FIGURE 31: : DIMENSIONS TX MVDS2	24
FIGURE 32: CONNECTORS RX MVDS2	25
FIGURE 33: DIMENSIONS RX MVDS2	25

2 General Description.

MVDS2 is the new version of Elber Multichannel audio/video distribution system; it has been designed to transmit or transfer combined DVB-S/S2 carriers or full satellite transponders at Ku-band frequencies.

MVDS2 is a fully weatherproof IP65 housing suitable for outdoor installations in harsh environments, available in two version, standard or high power; the standard version hosts GaAs FET transistor as final stage, while the high power utilizes GaN FET. GaN technology achieves higher efficiency and superior performances in terms of linearity compared to the GaAs.

The system is protected with automatic squelch of final stages in case of critical temperature or power overload.

The management and monitoring of the equipment can be achieved through a very easy and intuitive web interface.

3 Installation.

- Unpack the equipment and check first check if there are any damages due to the transport.
- The box should contain:
 - The MVDS2
 - One envelope with customer's default password and user manual
 - One power supply connector
 - One M&C connector
- Install the equipment on a mast.
- The equipment must be correctly grounded, to guarantee a secure functioning.
- Connect to the correct power voltage reading the information on the manual or on the label attached to each equipment, containing the serial number.
- Connect the network cable to the plug. The last used configuration will be loaded.
- Setup the equipment according to the needs consulting the user manual.

4 Technical Specifications.

4.1 General specifications.

Operating temperature range	-10°C ÷ 55°C
Relative Humidity	0 ÷ 95°C condensing
Power supply	22 ÷ 28 V (2 pin connector)
Maximum Power consumption Tx	< 125 W (typical 100 W for Tx 12 GHz) (typical 80 W for Tx 14 GHz)
Maximum Power consumption Rx	< 25 W (typical 17 W)
Controls	Ethernet Embedded Web Server SNMP

4.2 Mechanical specifications.

Width	99.7 mm Rx / 152.0 mm Tx
Height	217.5 mm (including connectors)
Depth	321.0 mm
Weight	< 12 Kg

4.3 System specifications.

4.3.1 Transmitters

L-Band input connector	N (F) 50 ohm
VSWR RF In	1.23:1
RF output connector	WR75 flange PBR120 50 ohm
VSWR RF Out	1.3:1
Input L-Band and Output Frequency range	1440-1800 MHz -> 13520-13880 MHz (Low Band) 950-1310 MHz -> 13500-13860 MHz (Low Band) 1440-1800 MHz -> 14020-14380 MHz (High Band) 950-1310 MHz -> 14000-14360 MHz (High Band) 950-1310 MHz -> 14100-14460 MHz (High Band) 1000-1760 MHz -> 14.0-14.8 GHz (High Band)* special range 1000-1760 MHz -> 13.2-14.0 GHz (Low Band) * special range 1000-1760 MHz -> 11.7-12.5 GHz * special range Any other combination depending on LO, fully synthesizable
Output Power @ 1 dB c.p.	44.0 dBm (25W) high power option on 14.00-14.50 GHz 44.0 dBm (25W) high power option on 13.50-14.00 GHz 41.7 dBm (15W) high power option on 10.70-11.70 GHz 41.7 dBm (15W) high power option on 11.70-12.50 GHz 37.5 dBm (6W) standard power option on 14.0-14.5 GHz 37.5 dBm (6W) standard power option on 13.5-14.0 GHz 39.0 dBm (8W) standard power option on 12.20-12.75 GHz 39.0 dBm (8W) standard power option on 11.70-12.25 GHz 39.0 dBm (8W) standard power option on 11.50-11.90 GHz 39.0 dBm (8W) standard power option on 11.10-11.50 GHz 39.0 dBm (8W) standard power option on 10.70-11.10 GHz
Spectral Regrowth	< -30 dBc (@1.0 x Symbol Rate in QPSK/8PSK)
Third order IMD (two Signal 5 MHz apart @ P _{LIN})	< -25 dBc

P_{LIN} (10 carriers) P_{LIN} =output power at specified spectral regrowth@1.0*symbol rate for QPSK/8PSK	34.0 dBm high power option on 14.00-14.50 GHz 34.0 dBm high power option on 13.50-14.00 GHz 31.5 dBm high power option on 10.70-11.70 GHz 32.5 dBm high power option on 11.70-12.50 GHz 27.0 dBm standard power option on 14.00-14.50 GHz 27.0 dBm standard power option on 13.50-14.00 GHz 27.0 dBm standard power option on 12.20-12.75 GHz 27.0 dBm standard power option on 11.70-12.25 GHz 27.0 dBm standard power option on 11.50-11.90 GHz 27.0 dBm standard power option on 11.10-11.50 GHz 27.0 dBm standard power option on 10.70-11.10 GHz
Gain (@ 0dB attenuation)	78.0 dB \pm 2dB High power option 50.0 dB \pm 2dB Standard power option
Gain regulation	18.0 dB in 0.1dB
Gain flatness	\pm 1.0 dB full band
Gain variation over temperature	\pm 1.0 dB max
Gain variation over temperature (open loop)	\pm 1.5 dB max
Gain variation over temperature (with AGC)	\pm 0.3 dB
Spurious emission	<-55 dBc @ P_{LIN}
Local Oscillator	Fully adjustable; standard examples as follow. <ul style="list-style-type: none"> • 12.58 or 13.05 GHz @14.00-14.50 GHz • 12.08 or 12.55 GHz @13.50-14.00 GHz • 10.60 or 11.40 GHz @12.20-12.75 GHz • 10.28 or 10.75 GHz @11.70-12.25 GHz • 10.08 or 10.55 GHz @11.50-11.90 GHz • 9.68 or 10.15 GHz @11.10-11.50 GHz • 9.28 or 9.75 GHz @10.70-11.10 GHz • 13.02 GHz @14.02-14.78 GHz (special range) • 12.22 GHz @13.22-13.98 GHz (special range) • 10.72 GHz @11.72-12.48 GHz (special range)
Input AGC Range	0 \div 35 dBm
Phase noise of BUC	1KHz - 95 dBc/Hz 10KHz -103 dBc/Hz 100KHz -105 dBc/Hz 1MHz -120 dBc/Hz 10MHz -125 dBc/Hz

4.3.1 Receivers

RF input connector	WR75 flange PBR120 50 ohm
VSWR RF In	1.22:1
L-Band Output connector	2 x N (F) 50 ohm
VSWR RF Out	1.15:1
Input Frequency range and Output L-Band	13520-13880 MHz (Low Band) -> 1440-1800 MHz 13500-13860 MHz (Low Band) -> 950-1310 MHz 14020-14380 MHz (High Band)-> 1440-1800 MHz 14000-14360 MHz (High Band)-> 950-1310 MHz 14100-14460 MHz (High Band)-> 950-1310 MHz 14.0-14.8 GHz (High Band)* special range -> 1000-1760 MHz 13.2-14.0 GHz (Low Band * special range -> 1000-1760 MHz Any other combination depending on LO, fully synthesizable
Gain flatness	\pm 1.0 dB full band

Gain variation over temperature	± 1.0 dB max
Gain variation over temperature (open loop)	± 1.0 dB max
Gain variation over temperature (with AGC)	± 0.3 dB
Local Oscillator	Fully adjustable; standard examples as follow. <ul style="list-style-type: none"> • 12.58 or 13.05 GHz @14.00-14.50 GHz • 12.08 or 12.55 GHz @13.50-14.00 GHz • 12.22 GHz @13.2-14.0 GHz *special range • 13.02 GHz @14.0-14.8 GHz *special range
AGC Dynamic Range	-15 ÷ -60 dBm
Output Level Adjustment	0 ÷ -20dBm
Frequency stability	1 ppm
Phase noise of BUC	1KHz - 95 dBc/Hz 10KHz -103 dBc/Hz 100KHz -105 dBc/Hz 1MHz -120 dBc/Hz 10MHz -125 dBc/Hz

5 Web interface.

MVDS2 is equipped with a WEB interface for an easy and intuitive monitoring and equipment configuration. The connection to Web server can be achieved through dedicated cable directly to the outdoor unit.

With a common *Web browser* (like Internet Explorer, Mozilla Firefox, Google Chrome, Opera, Safari...) it is possible to check equipment status and verify performances even remotely simply writing in the address bar the IP address of the equipment. To check the IP address, please refer to par 5.1.

Important Note: Default IP address is 192.168.10.150.

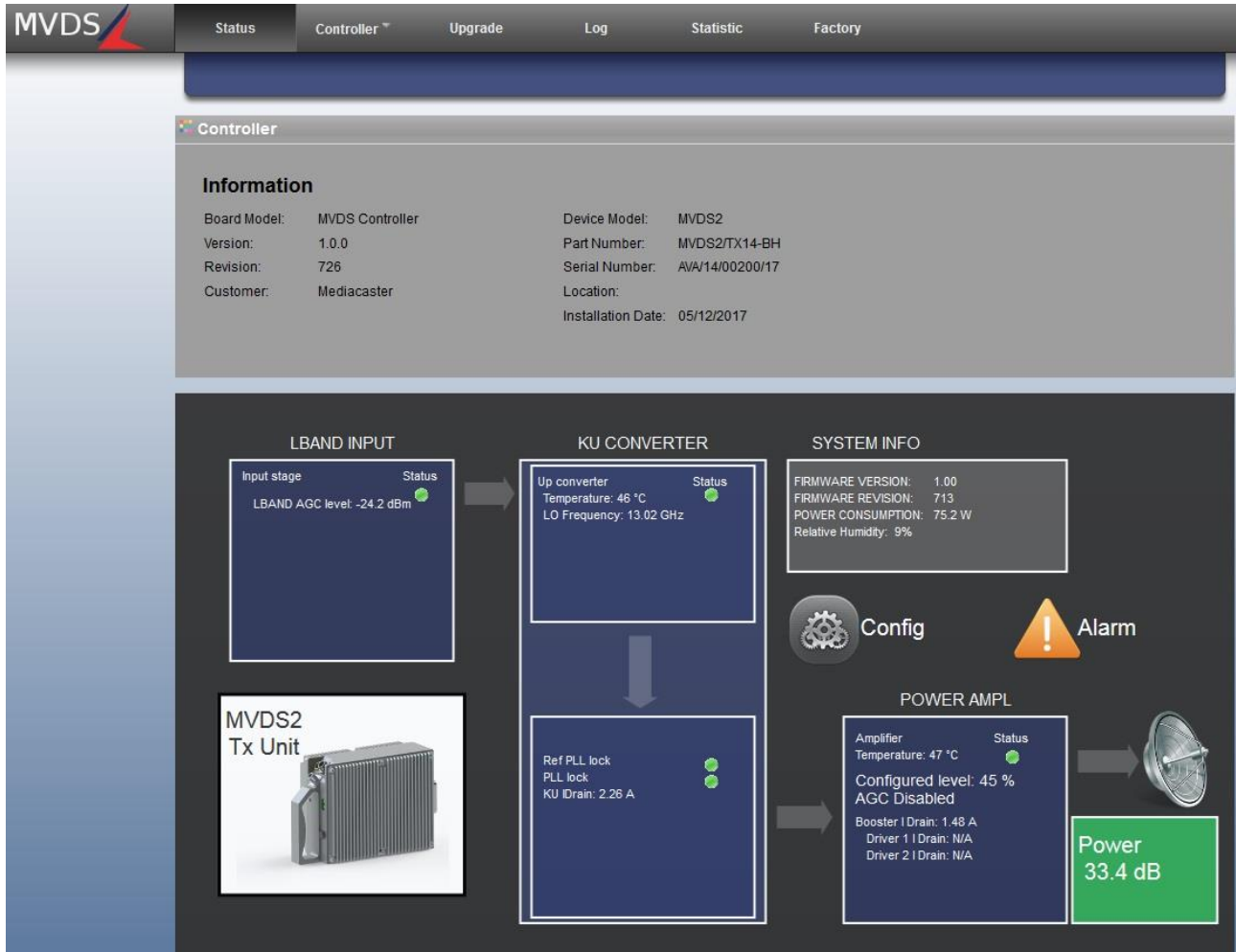

FIGURE 1: WEB INTERFACE TX HOME PAGE

Figure 1 shows the home page of the Web interface, which by default is the Status Page, in case of transmitter.

5.1 Common Parts.

5.1.1 Status.

The screenshot shows a web interface for a Controller. At the top, there is a tab labeled 'Controller'. Below it, the 'Information' section contains the following data:

Board Model:	MVDS Controller	Device Model:	MVDS2
Version:	1.0.0	Part Number:	MVDS2/TX14-AH
Revision:	726	Serial Number:	AVA/14/00193/17
Customer:	Mediacaster	Location:	
		Installation Date:	05/12/2017

FIGURE 2: WEB STATUS FORM - COMMON PARAMETERS

The upper part of the status page (home page of the web interface) shows general information such as the software versions, S/N, P/N.

5.1.2 Controller.

5.1.2.1 Controller Tab – Customer.

The screenshot shows the 'Controller' tab selected in a navigation menu. The 'Customer' sub-tab is active, displaying the following form fields:

- Customer name:
- Location:
- Installation Date:

Below the form is an 'Apply' button. A dropdown menu is open over the 'Customer' tab, showing options: » Customer, Network, Traps Manager, Tools, and Password management.

FIGURE 3: WEB CONTROLLER TAB – CUSTOMER PARAMETERS.

Field	Description
Customer Name	Factory Reserved – indication of the customer name
Location	Let the user write the installation site of the equipment
Installation Date	Let the user set the installation date

5.1.2.2 Controller Tab – Network.

Network Management

Ip address:

Netmask:

Gateway:

MAC address:

Domain name server:

NTP server:

Timezone (correction for NTP sync)

Select your country and timezone

Time zone:

Country:

FIGURE 4: WEB CONTROLLER TAB – NETWORK PARAMETERS.

This frame let check and modify network parameters of the user interface.

IP Address, Netmask and Gateway Address can be modified by the user writing in the dedicated text box while Mac Address is read-only. Moreover, it's possible to configure a DNS, a NTP server IP address, the Time Zone and the Country where the equipment is installed.

Field	Description
IP Address	Let the user set the IP address of the equipment
Netmask	Let the user set the IP subnet mask of the equipment
Gateway	Let the user set the Gateway IP address of the equipment
MAC Address	Shows the equipment MAC address
Domain name server	Let the user set the IP address of a DNS server
NTP server	Let the user set the IP address of an external NTP server

To confirm modifications, it is necessary to push on "APPLY" to validate.

5.1.2.3 Controller Tab – Traps Manager.

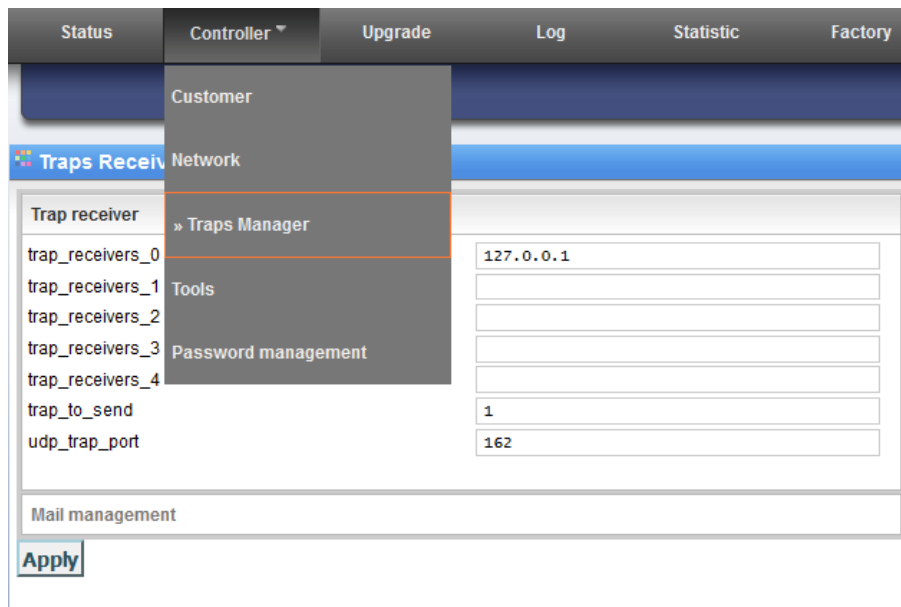

FIGURE 5: WEB CONTROLLER TAB – TRAPS MANAGER

Field	Description
Trap_receivers_0 to 4	Let the user set up to 5 destinations for SNMP traps sending
Trap_to_send	Let the user set the number of messages to be sent as Trap for every alarm event
Udp_trap_port	Let the user set the UDP port for Traps sending (default port = 162)

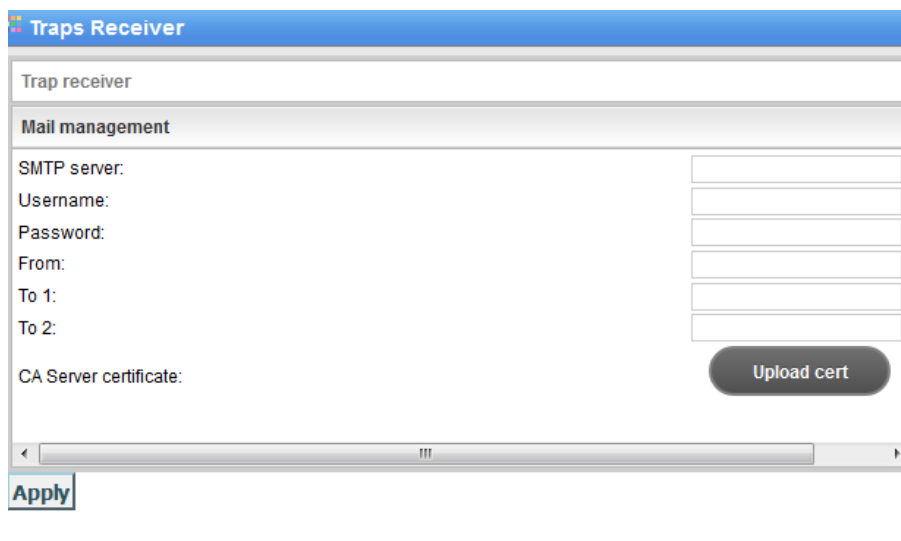

FIGURE 6: WEB CONTROLLER TAB – TRAPS MANAGER EMAIL

Field	Description
SMTP server	Let the user configure a SMTP server for mail sending
Username	Let the user configure the username of the mailbox
Password	Let the user configure the password of the mailbox
From	Let the user configure the Sender of the mail message
To 1	Let the user configure the first destination of the mail message
To 2	Let the user configure the second destination of the mail message
CA Server Certificate	Let the user upload the CA certificate of the mail server (Mandatory)

5.1.2.4 Controller Tab – Tools.

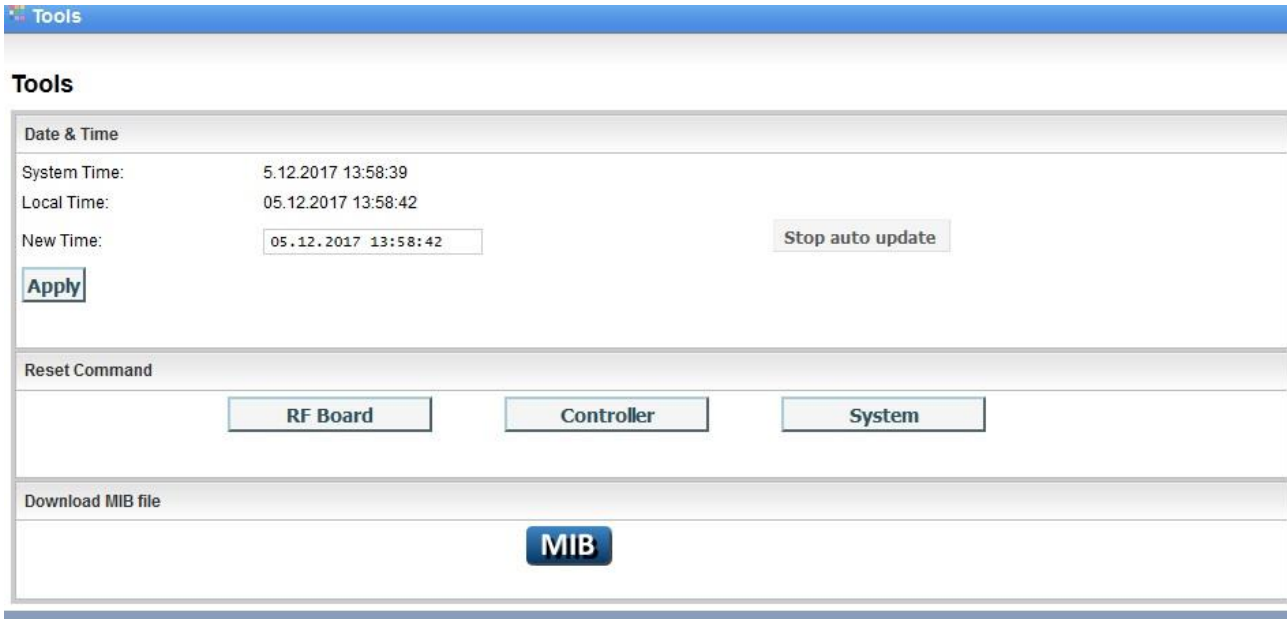

FIGURE 7: WEB CONTROLLER TAB – TOOLS

System Time	Indication of the system Time
Local Time	Indication of the local Time
New Time	Text box to modify local time.

The “Reset Command” subsection let the user send a reset pulse to related subsections separately, i.e. the RF Board microcontroller, the system controller and the whole system.

The MIB icon let the user download the SNMP MIB file.

5.1.2.5 Controller Tab – Password management.

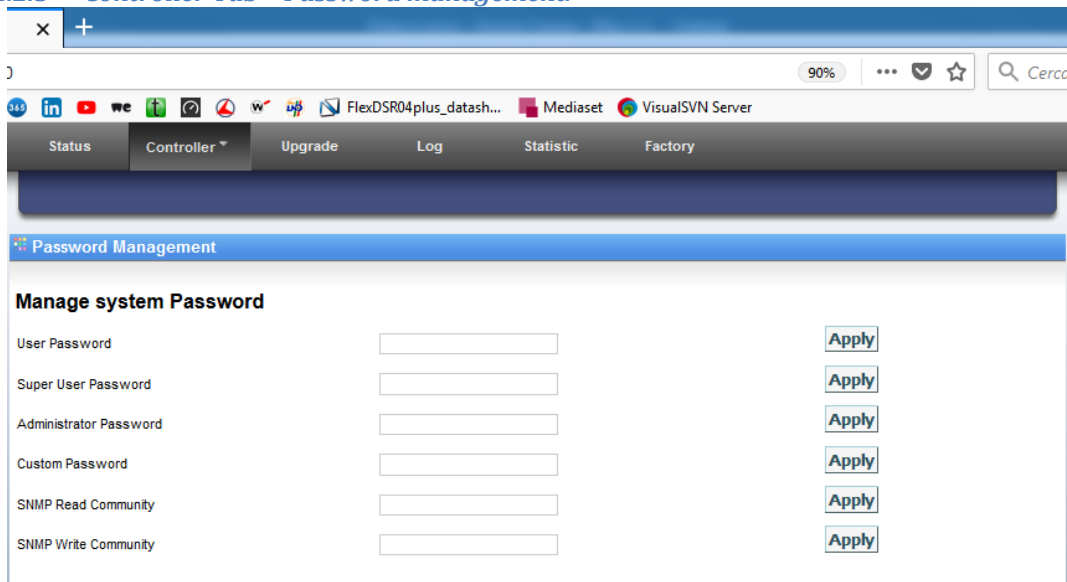

FIGURE 8: WEB CONTROLLER TAB –PASSWORD MANAGEMENT.

This form let modify the passwords for web interface and the SNMP communities.

Passwords should be composed of at least six characters and cannot overcome fifteen characters.

The password level that can be modified is subject to the rights of the user. The user “User” cannot change passwords.

User “Super-User” can change its own and the “User” ones. The “Administrator” can change any password.

5.1.3 Upgrade.

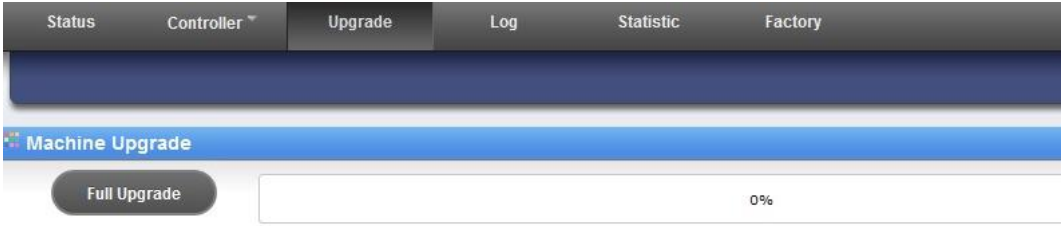

FIGURE 9: WEB UPGRADE FORM.

This form let the administrator of the system upgrade the units. Clicking on Full Upgrade, the user is asked to select a file browsing on its laptop that will be immediately sent to the system controller, starting the update process; this process can stop the equipment functioning until it finishes.

5.1.4 Log.

Status
Controller™
Upgrade
Log
Statistic
Factory

Available log

Log content

Log

- Today
- Yesterday
- Last Week
- Last Month

Erase Until

Yesterday ▼

APPLY

Today

Date	Event Type	Description	Origin
	Select Filter ▼	<input type="text"/>	Select Filter ▼
2017-12-05 14:12:19	MESSAGE	UPGRADE COMPLETE	NBFM_UPD...
2017-12-05 14:12:17	ALARM	Power loss at 13:59:24 5/0/2018	MVDS_MON...
2017-12-05 14:12:10	MESSAGE	WDT ENABLED	LOGMANAG...
2017-12-05 14:12:09	MESSAGE	LOG MANAGER STARTED	LOGMANAG...
2017-12-05 14:11:33	MESSAGE	Going to Reboot	NBFM_UPD...
2017-12-05 14:11:33	MESSAGE	LOG MANAGER KILLED	LOGMANAG...
2017-12-05 14:11:26	MESSAGE	Upgrading Controller	NBFM_UPD...
2017-12-05 14:11:26	MESSAGE	Move file to current	NBFM_UPD...
2017-12-05 14:11:26	MESSAGE	Going to Reboot	NBFM_UPD...
2017-12-05 14:10:59	MESSAGE	Upgrading uC...	NBFM_UPD...
2017-12-05 14:10:49	MESSAGE	Extacting Upgrade	NBFM_UPD...
2017-12-05 14:02:21	ALARM	Power loss at 13:59:24 5/0/2018	MVDS_MON...
2017-12-05 14:02:17	MESSAGE	LOG MANAGER STARTED	LOGMANAG...
2017-12-05 14:02:17	MESSAGE	WDT ENABLED	LOGMANAG...
2017-12-05 13:58:26	MESSAGE	TX_BOOSTER low_power ALARM RECOVERED	MVDS_MON...
2017-12-05 12:25:38	ALARM	TX_BOOSTER low_power ALARM OCCURRED	MVDS_MON...
2017-12-05 12:25:37	ALARM	Power loss at 12:4:41 5/0/2018	MVDS_MON...
2017-12-05 12:25:33	MESSAGE	LOG MANAGER STARTED	LOGMANAG...
2017-12-05 12:25:33	MESSAGE	WDT ENABLED	LOGMANAG...
2017-12-05 11:46:59	MESSAGE	TX_BOOSTER low_power ALARM RECOVERED	MVDS_MON...

Go to page: Show rows: 1-20 of 42 ◀ ▶

Save Log as:

XLS
XML
CSV
TSV
HTML
JSON

FIGURE 10: WEB LOG

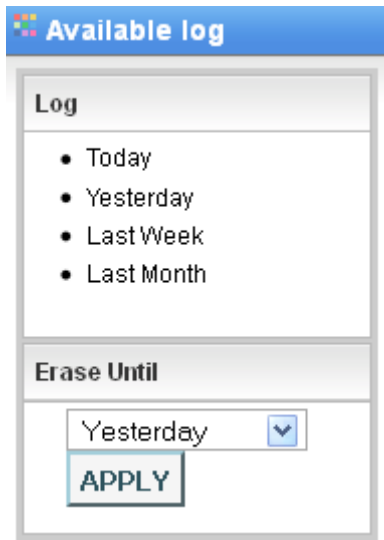

FIGURE 11 : WEB LOG FORM – AVAILABLE LOG.

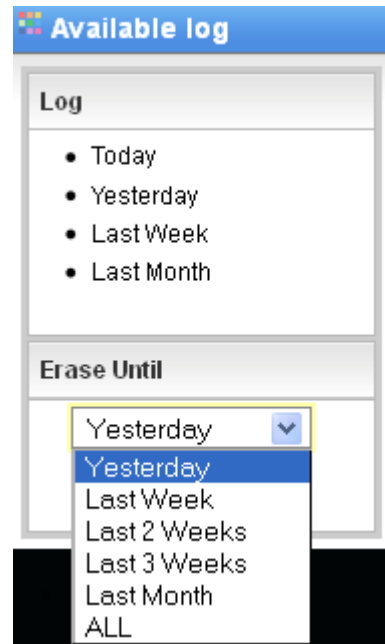

FIGURE 12: WEB LOG FORM – AVAILABLE LOG EXPANDED.

The equipment offers an operation log service that can be checked in this tab of the web interface.

In left part of the web page, the form concerning available logs is present, grouped by:

- Daily report
- Last day
- Last week
- Last month

To avoid huge memory usage and to accelerate log loading and showing, it is recommended to delete old records using **Erase until** form and selecting desired interval (Figure 12).

In central part of the page, log messages are reported, organized in a table that can be ordered, filtered and resized in terms of number of rows per page.

Records belong to 4 different categories are shown with different colors for user facility:

1. Messages
2. Configurations
3. Alarms
4. Warnings

Every record has a time, a description and an origin; an alarm event is described in appendix with OCCURRED tag, while the alarm condition recovery is a Message with appendix RECOVERED. Records can be ordered in every column and filtered (with related checkbox).

Log can be saved on user laptop as .xls, .xml, .csv, .tsv, .html or JSON file clicking on related icons.

5.2 Transmitters.

5.2.1 Status.

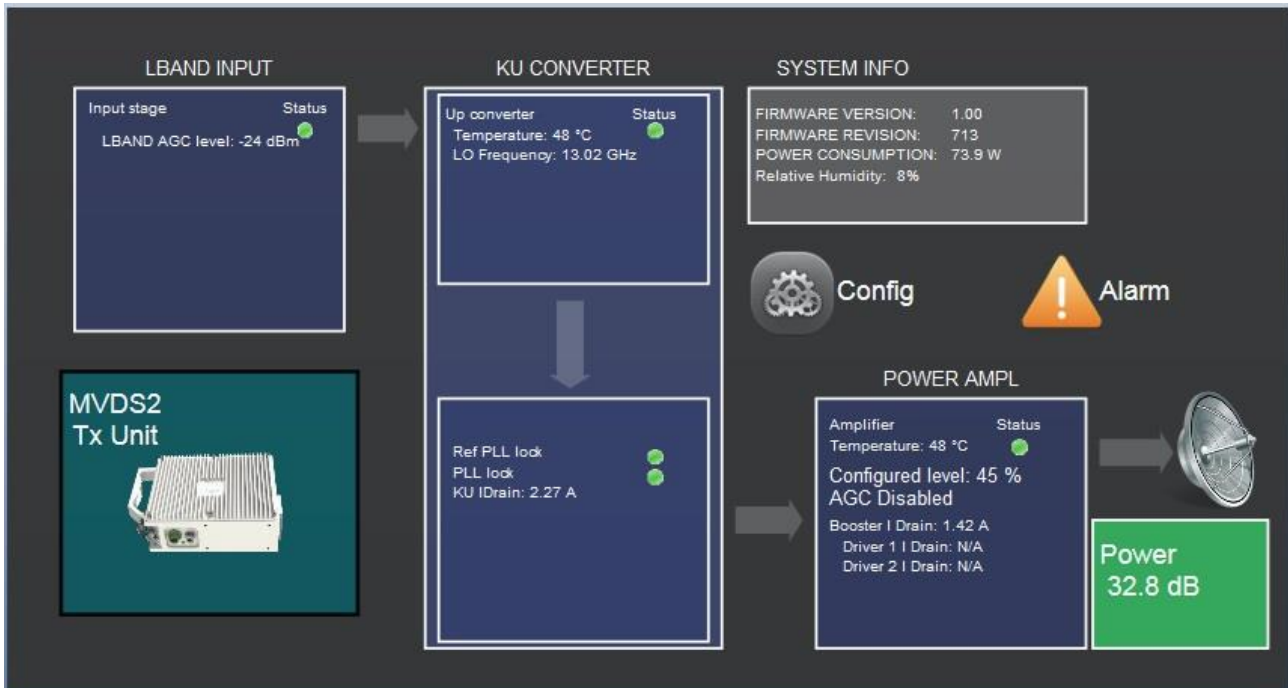

FIGURE 13: Tx STATUS PAGE

The status page is composed of 6 blocks; in the right part, the grey box includes system information, that are:

- Firmware version
- Firmware revision
- Power consumption (in W)
- Relative Humidity

SYSTEM INFO	
FIRMWARE VERSION:	1.00
FIRMWARE REVISION:	713
POWER CONSUMPTION:	73.9 W
Relative Humidity:	8%

FIGURE 14: SYSTEM INFO

The blue boxes show graphically the different parts composing the system, that are:

- L-Band input
- KU converter
- Power Amplifier

For each part, a led icon resumes the sub-part status (green = ok; red = alarm; yellow = warning).



FIGURE 15: L-BAND INPUT STATUS

For the L-band stage, it's available the input level measurement in dBm as shown in Figure 15.



FIGURE 16: KU CONVERTER STATUS

The Ku converter board presents following measurements and/or information:

1. Temperature
2. Indication of oscillator frequency
3. Reference locking status
4. PLL Lock status

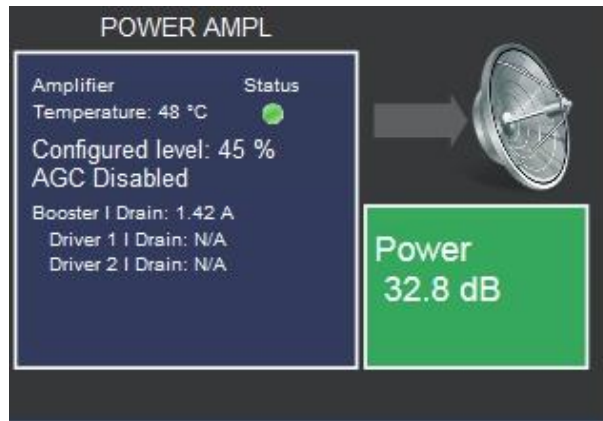

FIGURE 17: POWER AMPLIFIER STATUS

The Power Amplifier board presents following measurements and/or information:

1. Temperature
2. Configured output power in %
3. Indication of AGC stage enabling
4. Indication of current absorbed by final amplifier
5. Indication of current absorbed by driver stages (in 12 GHz version only)
6. Indication of Power output in dBm (the box is shown green if ok, red if alarm)

5.2.2 Config.

From the home page, by clicking on Config button, a new window opens.



FIGURE 18: CONFIG BUTTON

To modify any field shown in Figure 19 it is necessary to click on the Apply button to validate. Hereunder the list of field and related description.

Field	Description
Power Control	Let the user enable or disable the power amplifier, choosing between RF ON and RF OFF
Set Output Power	Let the user set the output power in % of the maximum power
Power AGC	Let the user enable/disable the output Automatic Gain Control (compensating temperature and input level variations)
LBand AGC	Let the user enable/disable the input Automatic Gain Control (cable loss compensation)
Manual L-Band input gain	Let the user set manually the input gain (LBand AGC off)
LBAND equalizer control	Let the user set manually the equalization of the L Band cable
Oscillator Frequency	Let the user configure the Oscillator frequency
KU conv. Warning Temp	Let the user set the temperature warning threshold
KU conv. Alarm Temp	Let the user set the temperature alarm threshold
Power Ampl. Warning Temp	Let the user set the power amplifier temperature warning threshold
Power Ampl. Alarm Temp	Let the user set the power amplifier temperature alarm threshold
Converter Traps	Let the user enable the Trap sending for Converter alarm events
Amplifier Traps	Let the user enable the Trap sending for Amplifier alarm events

System Traps	Let the user enable the Trap sending for System alarm events
Power point in dB	Let the user set the power out between a Lower threshold and a Higher threshold, after intermodulation check and power fine tuning.

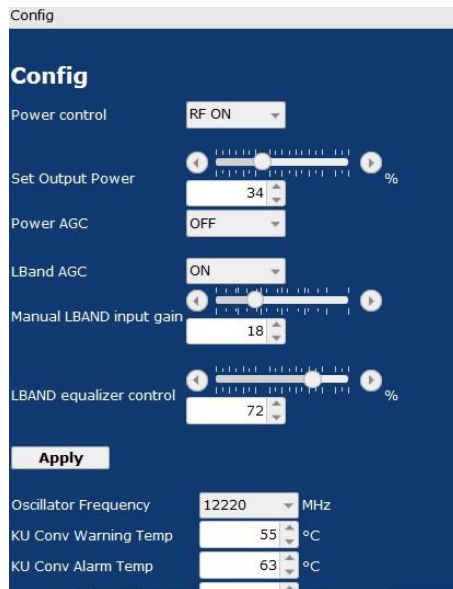

FIGURE 19: WEB INTERFACE TX CONFIG PAGE - 1.

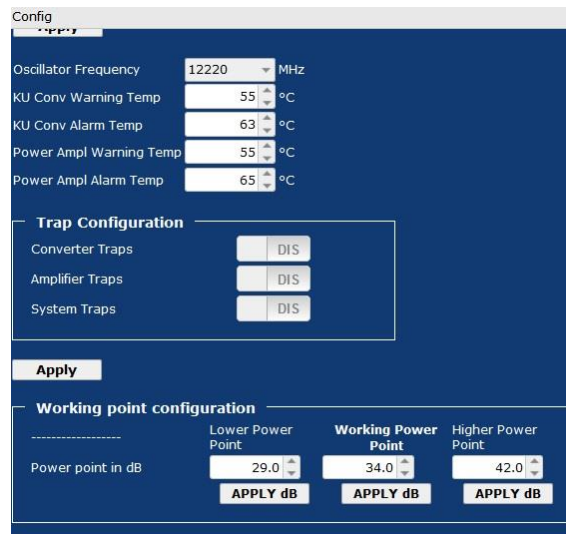

FIGURE 20: WEB INTERFACE TX CONFIG PAGE - 2.

5.2.3 Alarm.

From the home page, by clicking on Alarm button, a new window opens.



FIGURE 21: ALARM BUTTON

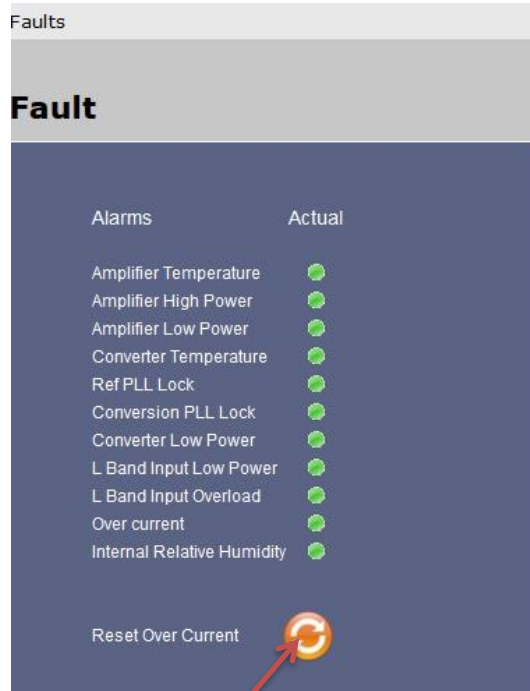

FIGURE 22: WEB INTERFACE TX ALARM PAGE.

Figure 22 shows alarms of the equipment.
The overcurrent alarm can be reset clicking here.

This is very important because, in case of Over Current event, the final amplifier is shut down until the alarm is reset.

6 Receivers.

6.1.1 Status.

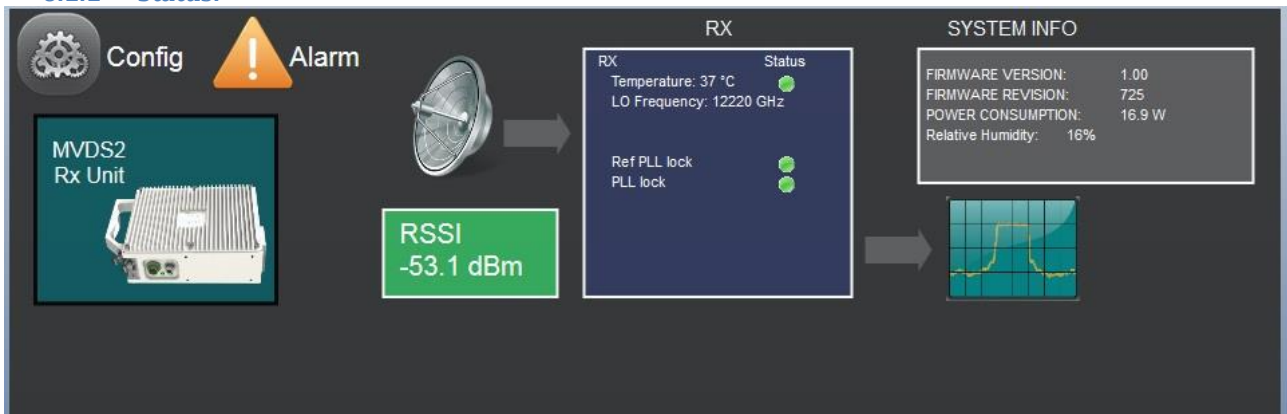

FIGURE 23: RX STATUS PAGE

The status page is composed of 3 blocks; in the right part, the grey box includes system information, that are:

- Firmware version
- Firmware revision
- Power consumption (in W)
- Relative Humidity

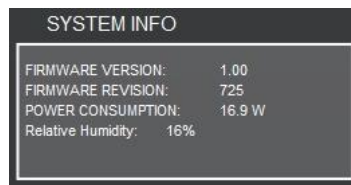

FIGURE 24: SYSTEM INFO

The blue box shows the receiver parameters; a led icon resumes the status (green = ok; red = alarm; yellow = warning) while besides an active window shows the Level received (RSSI, green if ok, red if below threshold).

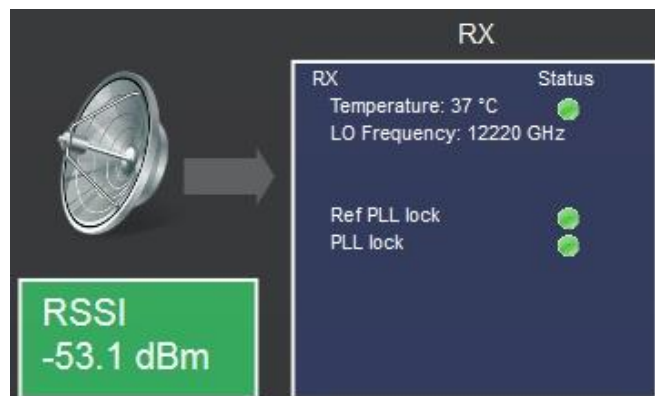

FIGURE 25: RECEIVER STATUS

The Receiver presents following measurements and/or information:

1. Temperature
2. Indication of oscillator frequency
3. Reference locking status
4. PLL Lock status

6.1.2 Config.

From the home page, by clicking on Config button, a new window opens.



FIGURE 26: CONFIG BUTTON

To modify any field shown in Figure 26 it is necessary to click on the Apply button to validate. Hereunder the list of field and related description.

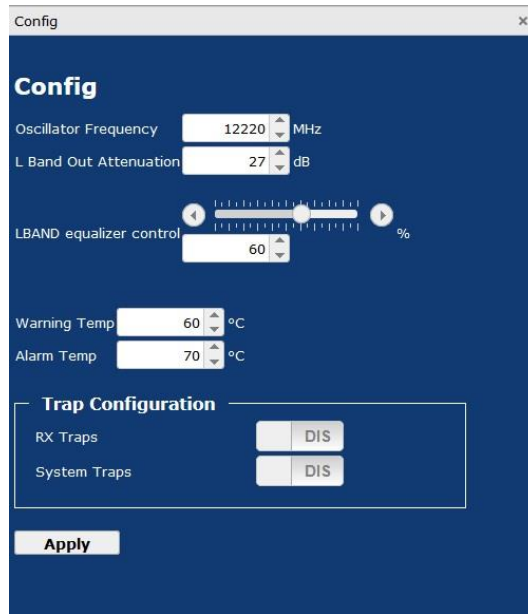

FIGURE 27: WEB INTERFACE RX CONFIG PAGE.

Field	Description
Oscillator Frequency	Let the user configure the Oscillator frequency
L-Band Out Attenuation	Let the user set manually the attenuation of the Output signal
LBAND equalizer control	Let the user set manually the equalization of the L Band cable
Warning Temp	Let the user set the temperature warning threshold
Alarm Temp	Let the user set the temperature alarm threshold
Rx Traps	Let the user enable the Trap sending for Receiver alarm events
System Traps	Let the user enable the Trap sending for System alarm events

6.1.3 Alarm.

From the home page, by clicking on Alarm button, a new window opens.



FIGURE 28: ALARM BUTTON

The screenshot shows a web interface titled 'Faults' with a sub-header 'Fault'. Below this is a table with two columns: 'Alarms' and 'Actual'. The table lists six different alarm types, each with a corresponding green dot in the 'Actual' column, indicating that all alarms are currently active.

Alarms	Actual
Rx Temperature	●
RX High RSSI	●
RX Low RSSI	●
Ref PLL Lock	●
Conversion PLL Lock	●
Internal Relative Humidity	●

FIGURE 29: WEB INTERFACE RX ALARM PAGE.

Figure 29 shows alarms of the equipment.

7 Mechanics and connectors.

7.1 Transmitters.

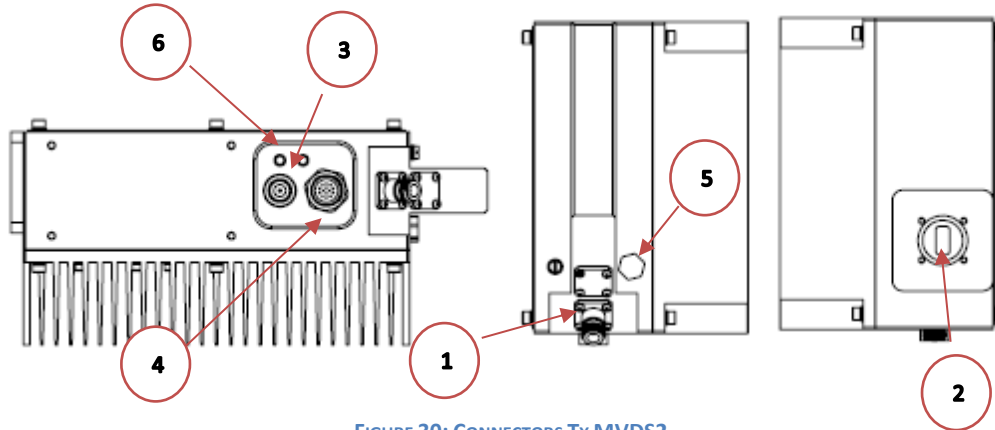

FIGURE 30: CONNECTORS Tx MVDS2

ID	Description	Function
1	RF IN	RF input connector N(f) type
2	RF OUT	Output waveguide flange WR75 (PBR120)
3	DC IN	N connector
4	M&Control	Control Connector 14 pin Amphenol Code: MS3114A12-14P
5	Valve Gore	Protection valve
6	LED	Status & Ethernet Activity Led

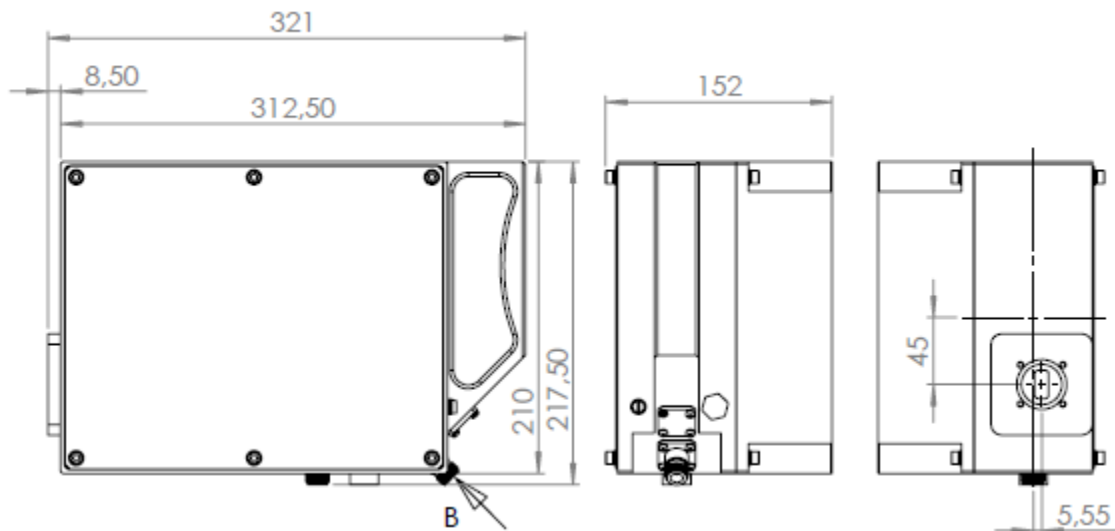

FIGURE 31: : DIMENSIONS Tx MVDS2

7.2 Receivers.

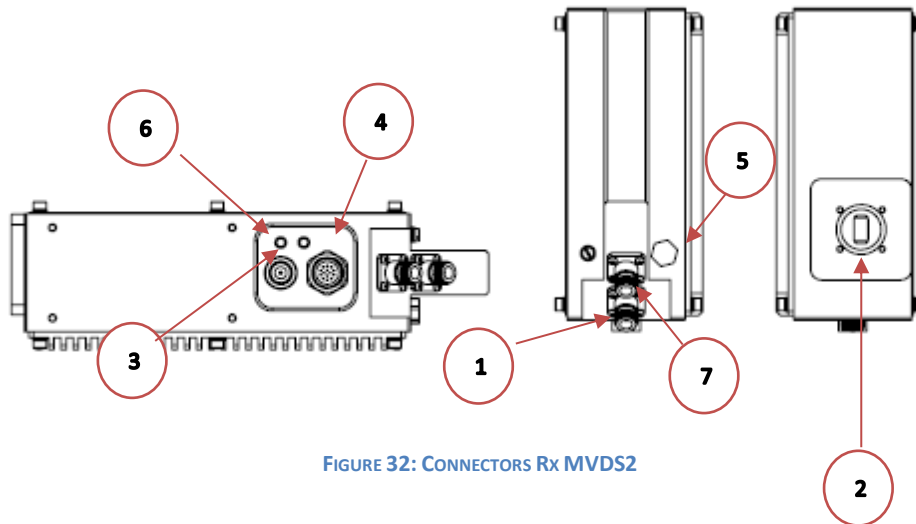

FIGURE 32: CONNECTORS Rx MVDS2

ID	Description	Function
1	RF OUT	RF output connector N(f) type
2	RF IN	Input waveguide flange WR75 (PBR120)
3	DC IN	N connector
4	M&Control	Control Connector 14 pin Amphenol Code: MS3114A12-14P
5	Valve Gore	Protection valve
6	LED	Status & Ethernet Activity Led
7	RF OUT 2	RF output connector N(f) type

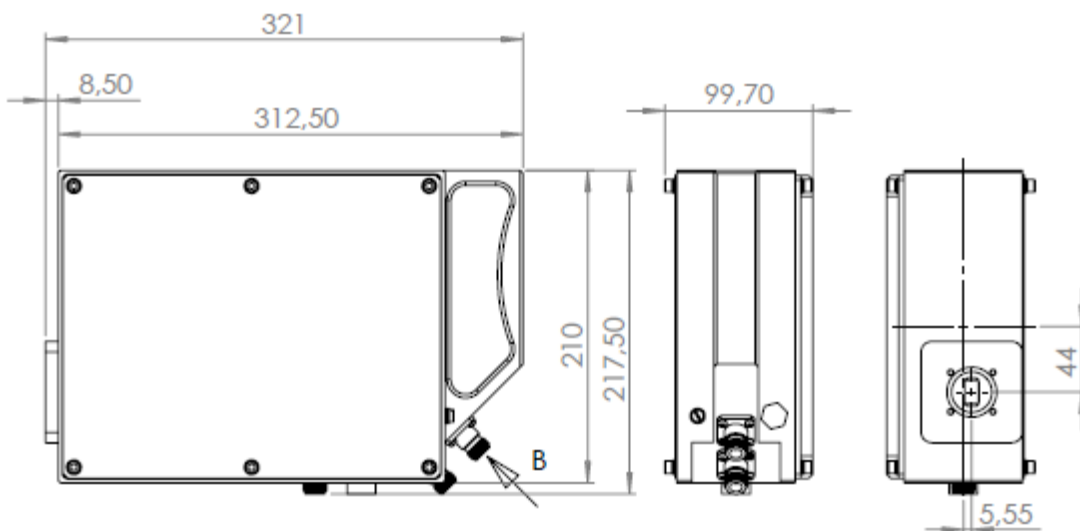

FIGURE 33: DIMENSIONS Rx MVDS2